

PART No. RCHS1901017

for more information visit
www.hammfg.com

Data subject to change without notice.
Isometric drawing not to scale.
Shipped knockdown for handling ease
& protection.

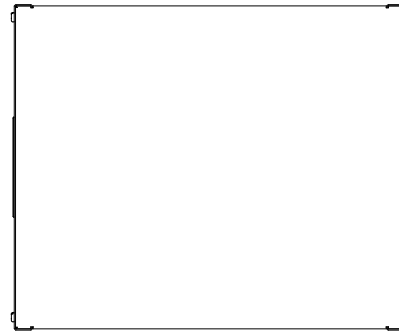

TOP VIEW

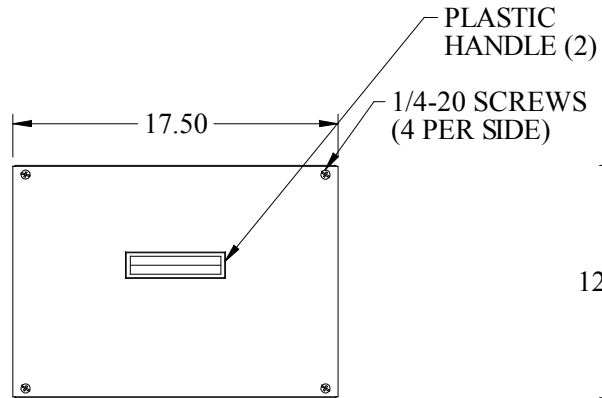
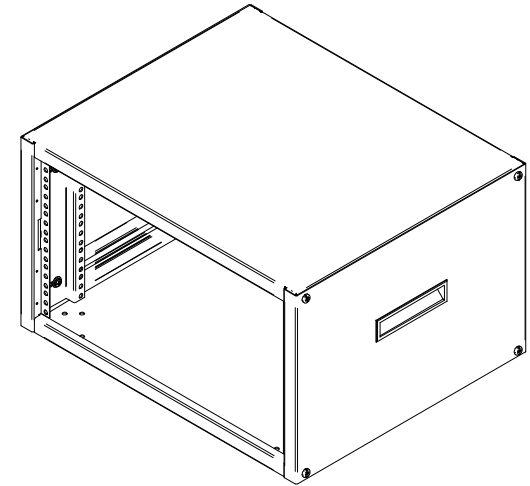

L.S. VIEW

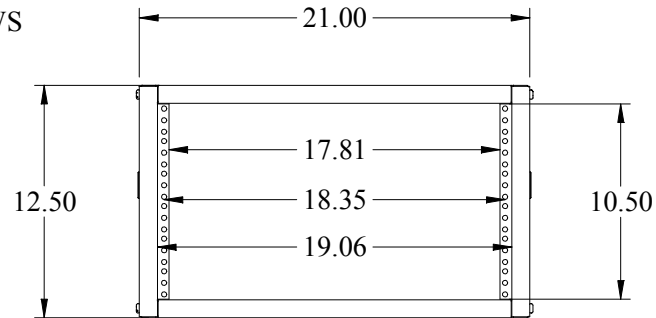

FRONT VIEW

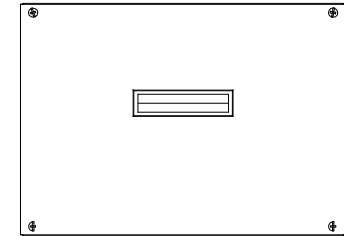

R.S. VIEW

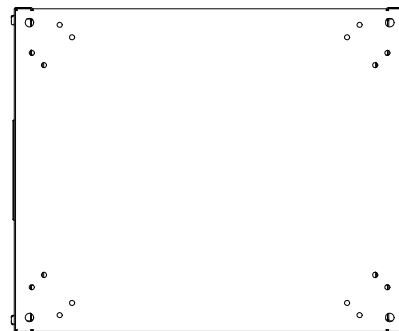

BOTTOM VIEW